

# Big can be that small.

**HE HOMAG**

**Our CNC Processing Center**  
DRILLTEQ V-200

**YOUR SOLUTION**







## DRILLTEQ V-200 – big can be that small.

**Fast processing – saves time**

**Takes up little room – saves space**

**Simple operation – saves nerves**

**Great value for money – saves money**

Our CNC processing centers offer the technology of the future today. And with good reason: Tradition. For us, it is both a motivation and a commitment. Customers the world over associate the very highest standards with this. And we meet those expectations.

### YOUR SOLUTION

**MORE: [HOMAG.COM](https://www.homag.com)**



### CONTENTS

- 04 Configurations
- 06 All inclusive – Hardware
- 08 Option – Plausibility Check
- 09 Option – Length-dependent processing in X-direction
- 10 Option – Robot Connection
- 12 powerTouch2
- 14 All inclusive – Software
- 15 Option – Software
- 16 tapio
- 18 Life Cycle Services
- 19 Technical Data

## Equipment packages for V8

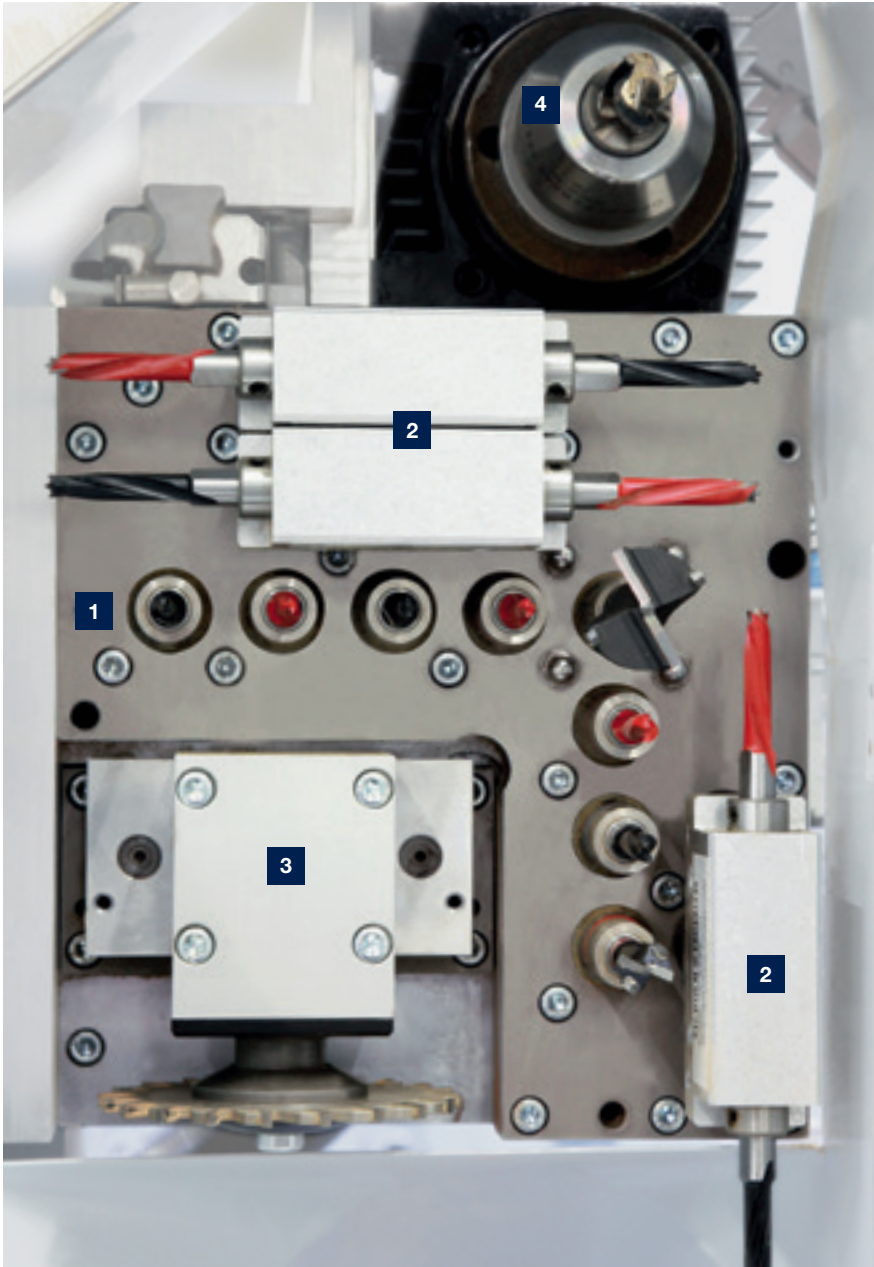

### STANDARD

- 1** 8 vertical High-speed drilling spindles, incl. quick change drilling system

### OPTIONS

- 2** Option – horizontal drilling
  - 4 High-speed drilling spindles in X-direction
  - 2 High-speed drilling spindles in Y-direction
- 3** Option – grooving
  - Grooving saw in X-direction, Ø 100 mm
- 4** Option – routing
  - Router motor with hydraulic quick-change system, 5 kW ETP 25



# Equipment packages for V13

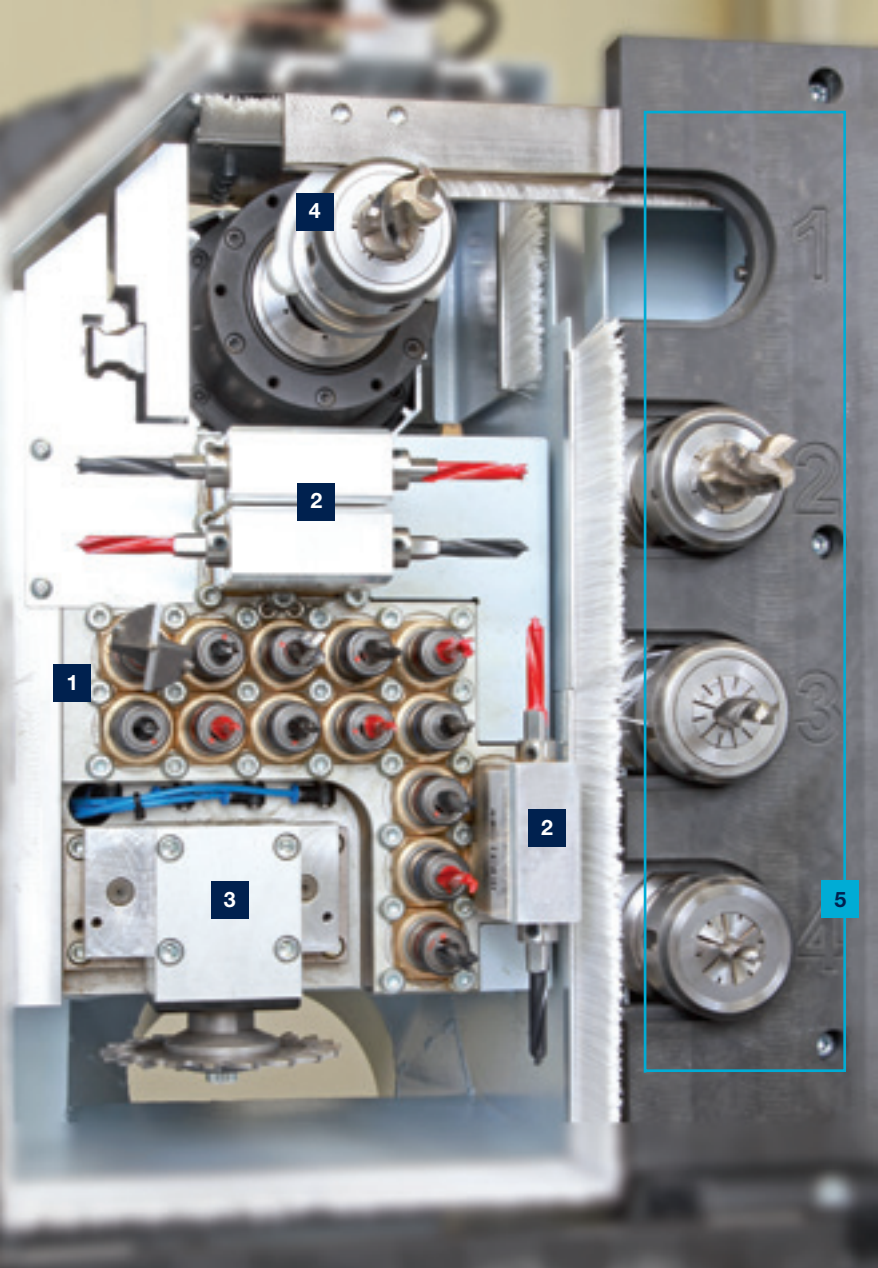

### STANDARD

- 1** 13 vertical High-speed drilling spindles, incl. quick change drilling system

### OPTIONS

- 2** Option – horizontal drilling
  - 4 High-speed drilling spindles in X-direction
  - 2 High-speed drilling spindles in Y-direction

- 3** Option – grooving
  - Grooving saw in X-direction, Ø 100 mm

- 4** Option – routing
  - Tool changing spindle 10 kW HSK 63

- Option – tool changer**
  - Automatic tool change magazine with 3 places. Extension of the tool change magazine by one place

- 5** Option – 4 places

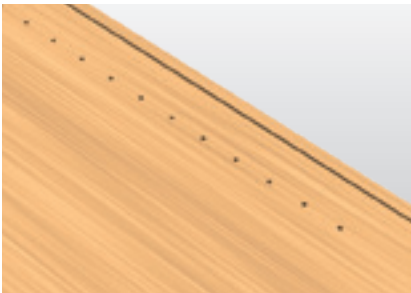

## All inclusive – Hardware

**TOP EQUIPMENT RIGHT FROM THE BEGINNING:** Already in the standard elementary technologies are included, which ensure sustainable highest processing quality.



### Workpiece load- and workpiece removal area

- Mechanical support via roller conveyor in the loading- and removal area of the machine

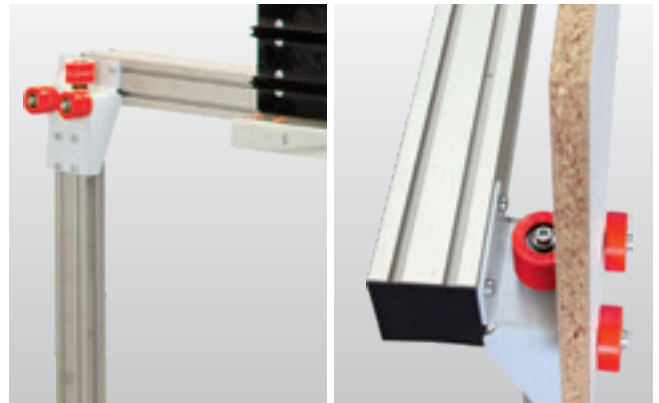

### Working length extension

- Extension of the working length from 2500 to 3050 mm incl. roller conveyor

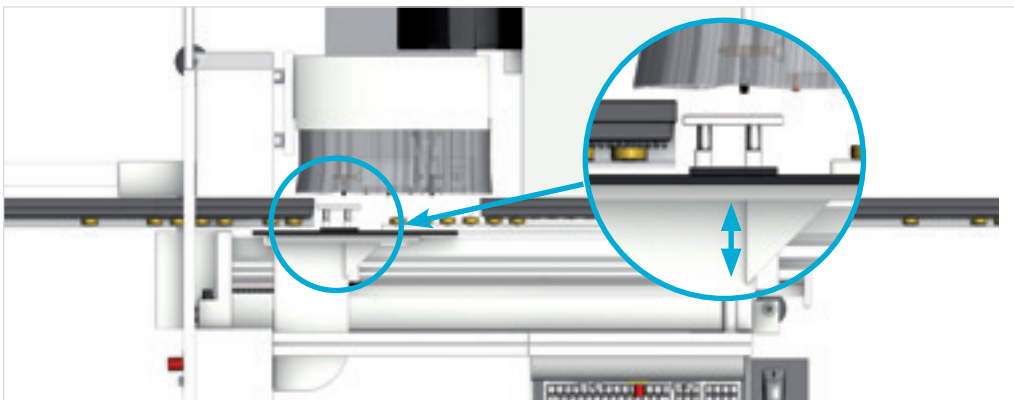

### Automatic workpiece thickness adjustment

- Automatic adjustment of the counter block to the material thickness according to the data preselected by the operator in woodWOP



### powerControl with powerTouch2

- Full-HD multitouch display with wide screen 16:9
- Front USB interface
- Ethernet connection 10/100 Mbit

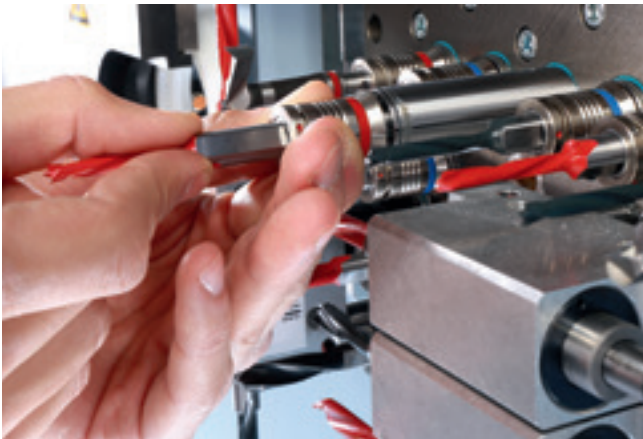

### Drill quick-change system

- The patented system ensures easy installation or change of drilling bits. Your easy way to save time!

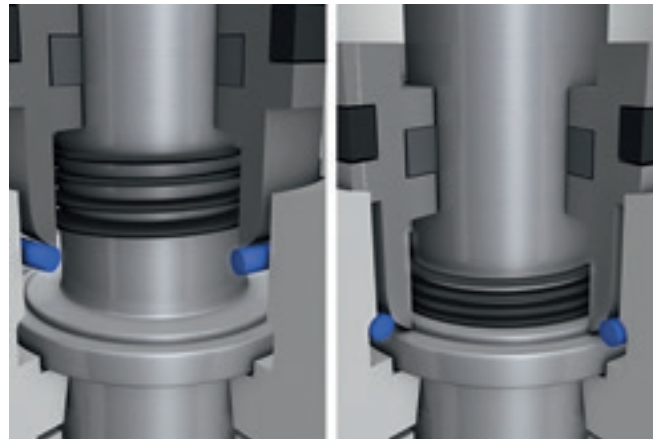

### Automatic spindle clamping

- Patented system for exact drilling depth at any time with different materials
- Lasting assurance of drilling quality

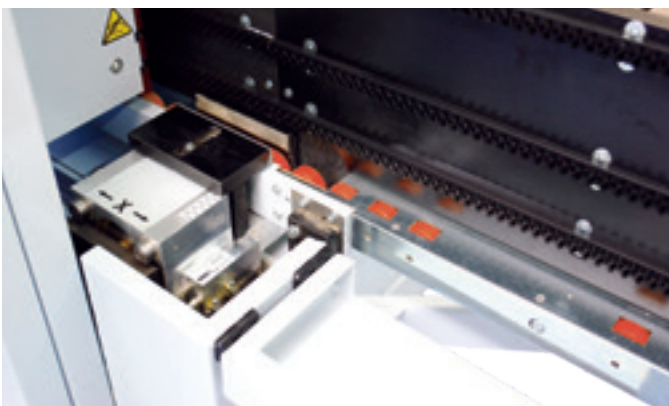

### Workpiece clamping device

- Easy adjustment of the clamping device (manually) to the workpiece thickness (clamping device stroke 10 mm). For differences in the workpiece thickness of up to 10 mm it is not necessary to manually adjust the clamping device.

# Option – Plausibility Check

## BENEFIT FROM ADDITIONAL SAFEGUARDING OF PROCESSES

Control of the workpiece by sensor technology in X- and Y-direction. Comparison with the values in the database. If the defined tolerance value is exceeded, the current process stops. At the same time the operator receives a message to correct the workpiece. This way you remain on the safe side.

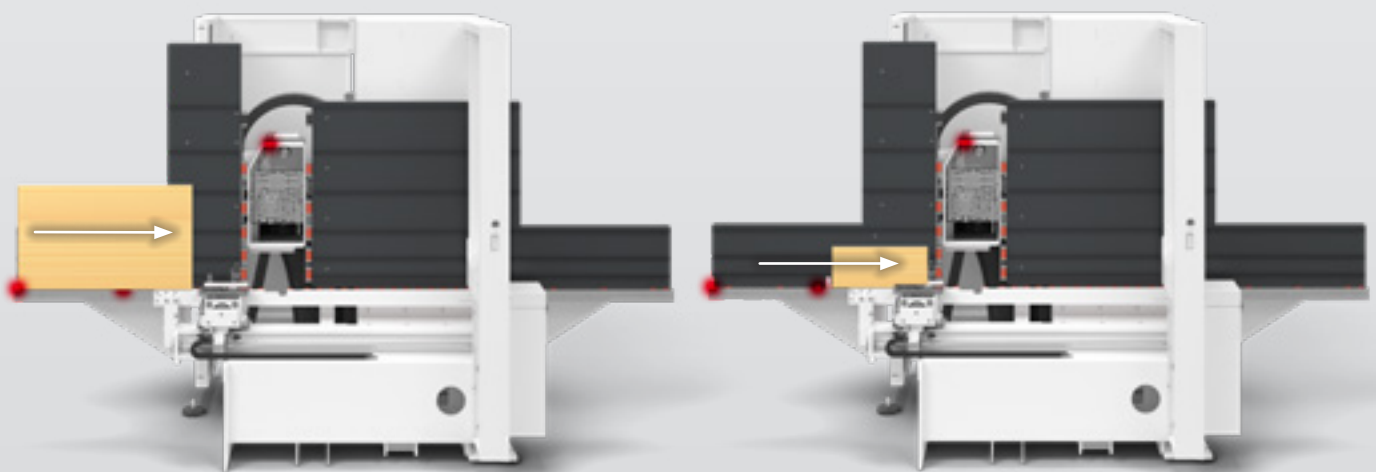

### Step 1:

- Positioning the workpiece

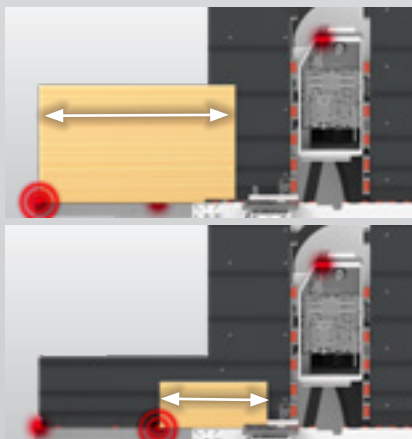

### Step 2:

- Control of the workpiece by sensor technology in X-direction. Depending on the workpiece dimensions the shortest distance to the next sensor is selected.

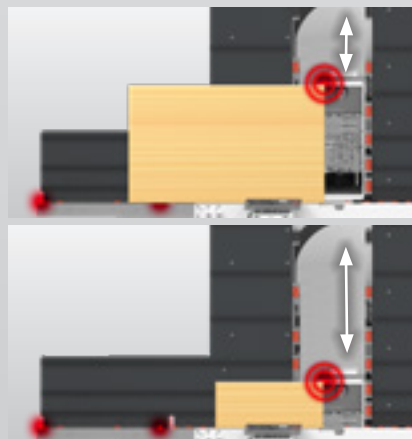

### Step 3:

- Control of the workpiece by sensor technology in Y-direction



### Step 4:

- Balancing the determined values with the program data:
- Tolerance of values < 5 mm – Program is continued.
- Tolerance of values > 5 mm – Program is stopped, advice to the operator to carry out the corrections.



## Option – Length-dependent processing in X-direction

### AUTOMATIC ADJUSTMENT OF DRILLINGS DEPENDING ON WORKPIECE DIMENSIONS

After the workpiece has been released for processing its length is measured accurately by a measuring run. Dimension-dependent drillings are then corrected automatically by possibly determined tolerances. You save time and gain quality.

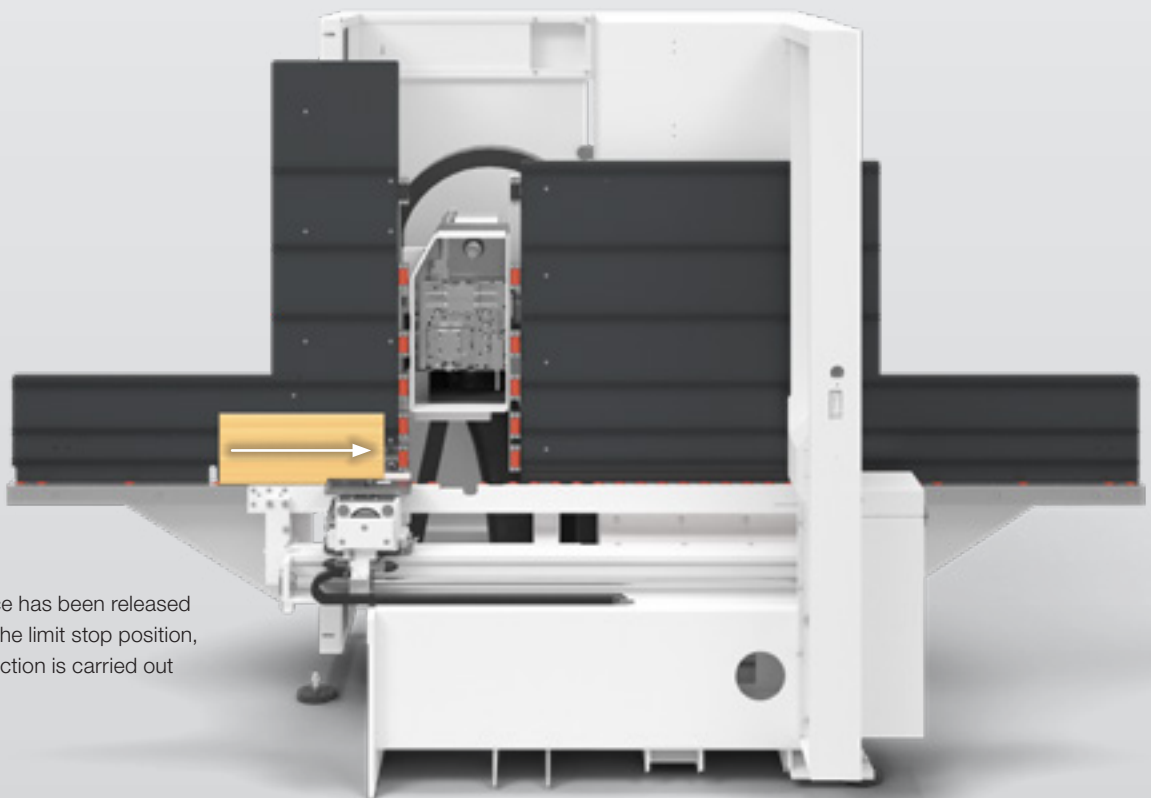

- After the workpiece has been released for processing at the limit stop position, a test run in X-direction is carried out (value 1).



- Determination of exact workpiece length (value 2).

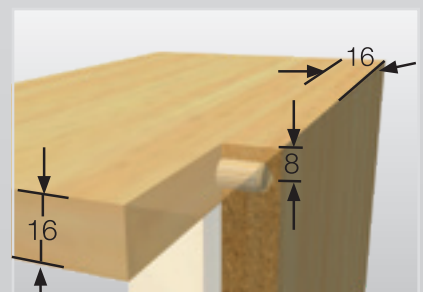

- Drills depending on dimensions are then automatically corrected by possibly determined tolerances.

## Option – Robot Connection

DRILLTEQ V-200 with robot. Safe, precise, automatic handling of workpieces for more efficient production.

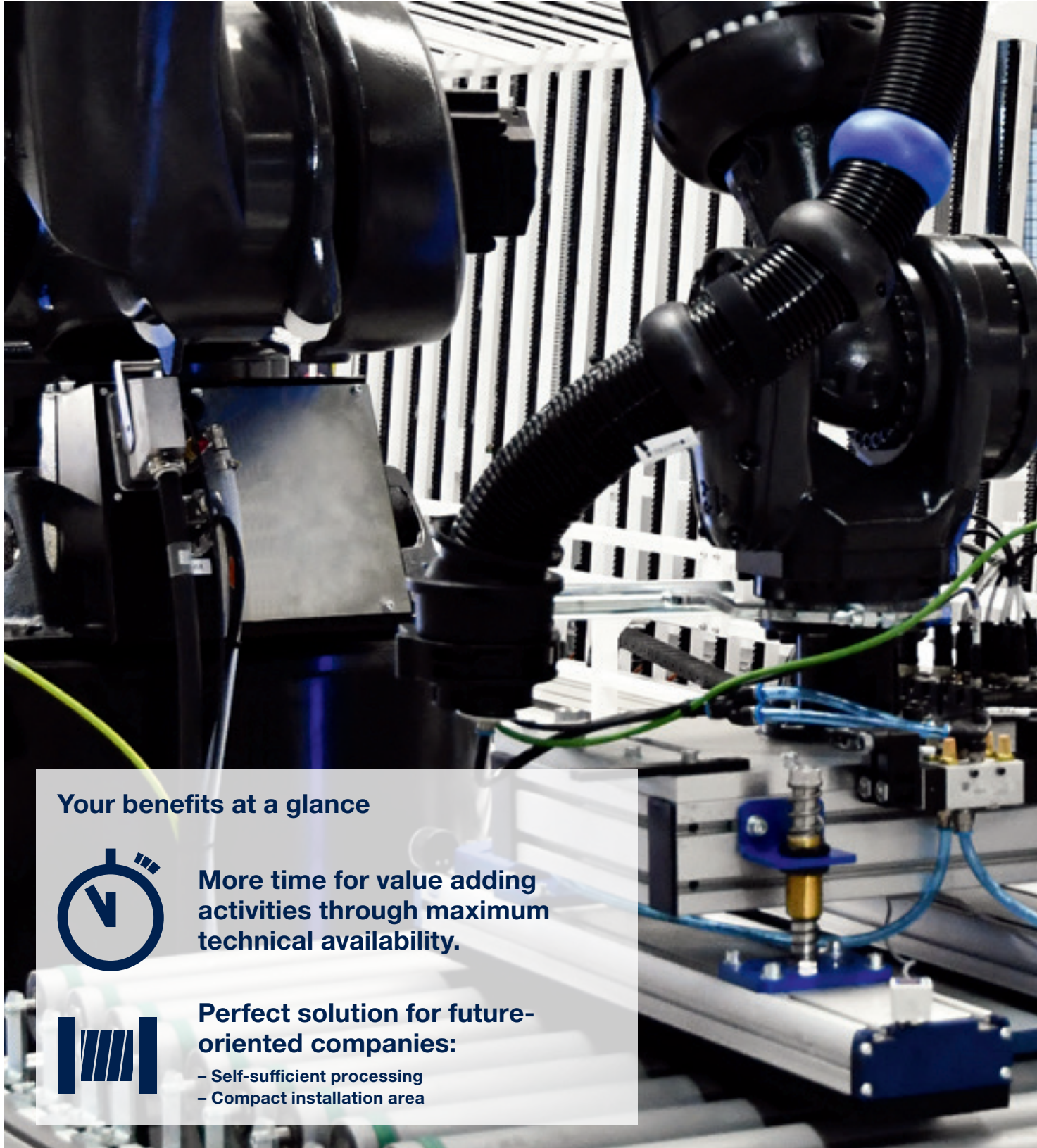

### Your benefits at a glance



**More time for value adding activities through maximum technical availability.**



**Perfect solution for future-oriented companies:**

- Self-sufficient processing
- Compact installation area

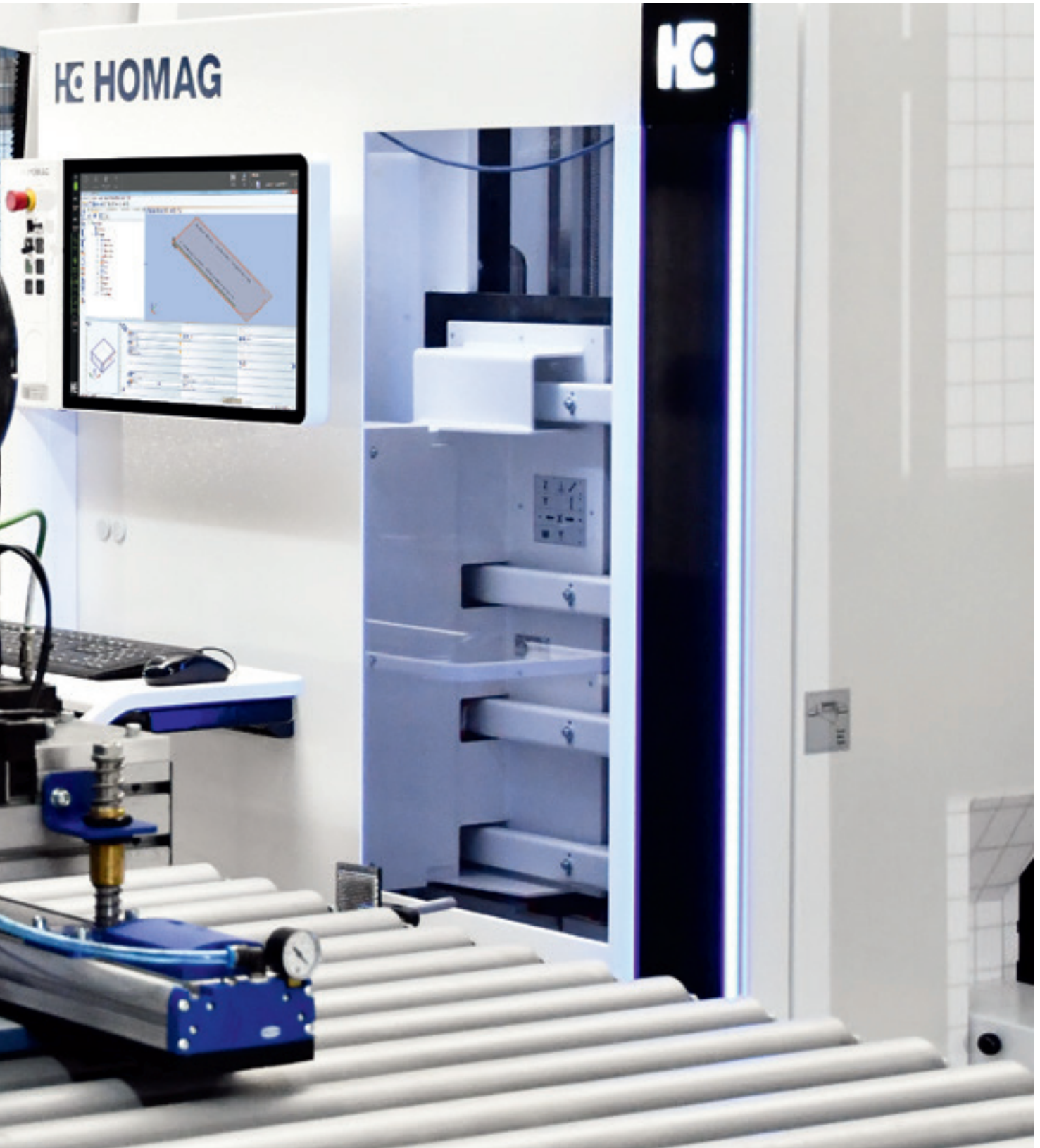

## The next generation of powerTouch: **powerTouch2**

Faster, more comfortable, clearer: Enjoy the benefits of our further improved powerTouch user interface. We have optimized our standardized operating concept and further adapted it to our customers' requirements.

Controlling your HOMAG machines is now even faster and more intuitive. The new, modern design has a clear structure. The innovative touch operation allows you to achieve the desired result easily and comfortably.



Our successful powerTouch philosophy —  
**simple, standardized, ergonomic, evolutionary** – consistently advanced

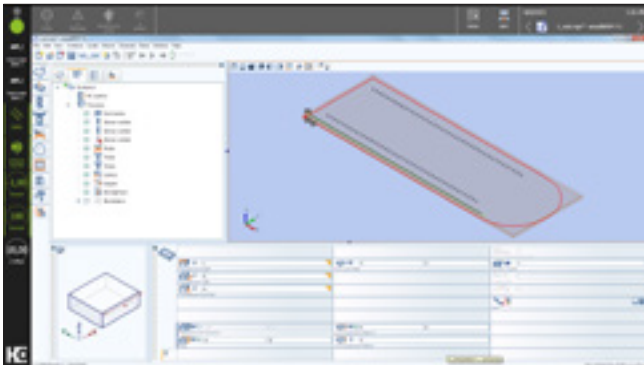

#### Clearer structure

The structure of the powerTouch2 screen is even clearer. You only see the information that is relevant for you. The important points at a glance – but you still have all the details. All in a fresh, attractive design.

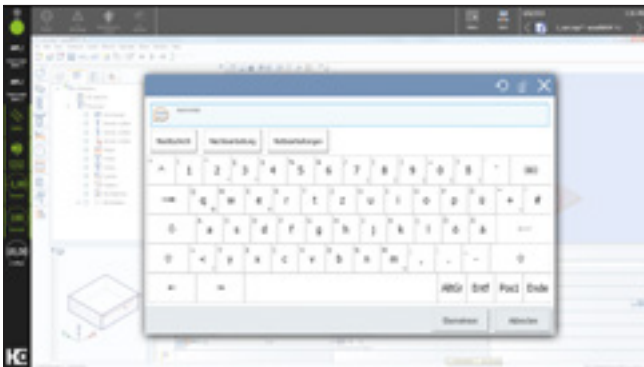

#### Even faster

With the new powerTouch generation, you can enter information at your machine even more quickly. Compared to the previous version, you can achieve a time saving of up to 30%. This is possible thanks to new features, such as automatic word completion, a pop-up keyboard that can be kept open and Windows-like functions, such as the selection of common actions directly via the start button.

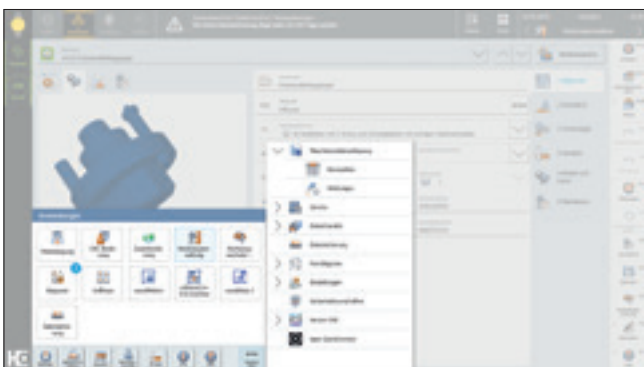

#### More comfortable

We have also improved the traffic light dialog and the “Start” menu. When you press and hold the program icon, not only are the possible actions displayed, you can also access and activate them directly. Operation is therefore immediate and you do not lose any time opening applications. What’s more, for the applications, illustrations and additional information can be displayed instead of simple program icons. This also provides more transparency and avoids unnecessary navigation into applications.



#### More intuitive

Operating the machine is child’s play. Many of the functions are similar to those of a smartphone or tablet and will therefore be familiar to you. Even beginners will feel immediately at ease and will soon be able to control the machine comfortably.

# All inclusive – Software

**WITH THIS SOFTWARE PACKAGE YOU ARE »READY TO RACE«.** You will receive one of the most established CNC-programming systems, the woodWOP software, which has proven itself by more than 30.000 installations worldwide.

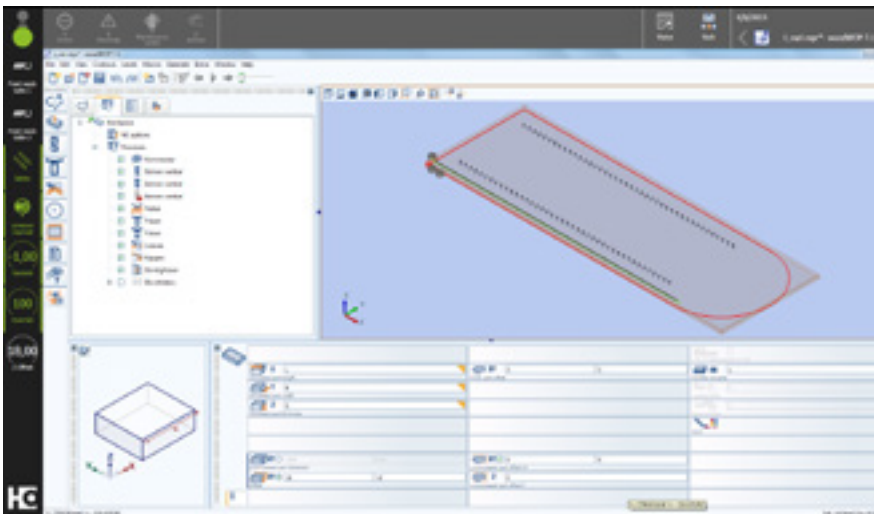

**Please use our website!**  
 Worldwide largest forum for woodWOP:  
[forum.homag.com](http://forum.homag.com)

## woodWOP | License Machine

- Fast and intuitive operation thanks to simple, direct navigation
- Select from a choice of variables for flexible variable programming
- Quickly create individual subprograms
- Increased programming security through 3D images of workpieces, processing and clamping equipment

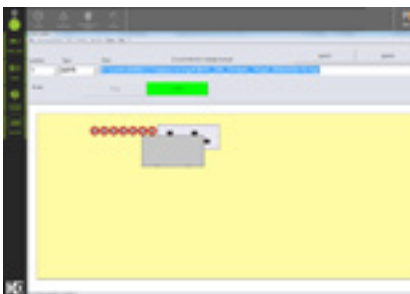

## Slot assignment

- Simple control of main machine functions through soft keys
- Graphical configuration
- Automatic mirroring of workpieces



## woodWOP DXF Basic

- Interface for CAD-Data Import
- Basis to generate woodWOP programs



## Machine data acquisition MMR Basic

- Record quantities and actual operating times on the machine
- Integrated maintenance instructions for optimum time and quantity-based planning, as well as performing maintenance

# Option – Software

**WITH ADDITIONAL SOFTWARE MODULES** you can further optimize your processes.

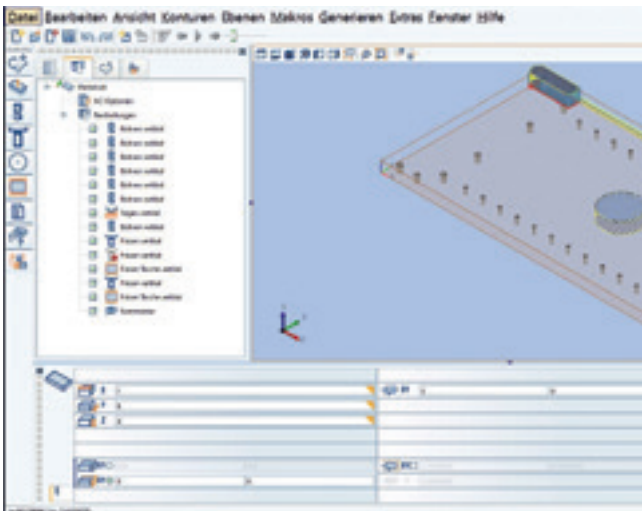

### woodWOP | License Office

- Single user or network licenses available
- Incl. DXF-Import CAD-Plugin to create your own CAD drawings on the machine and at the workplace

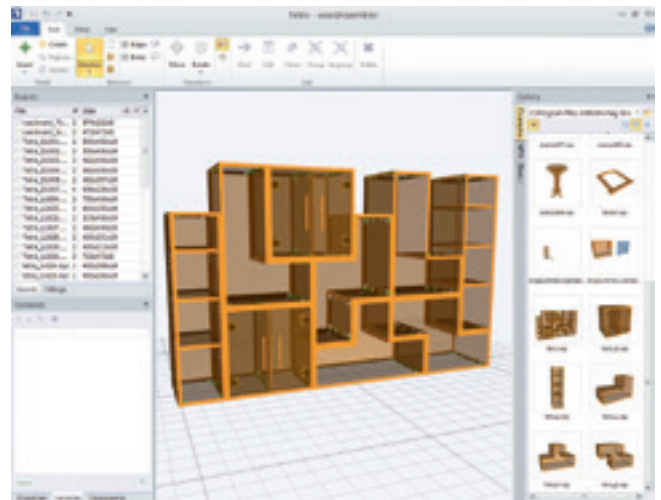

### woodAssembler

- To visualize woodWOP programs (MPR) in 3D
- Enables the construction of individual workpieces to finished objects



### 3D CNC-Simulator

- Simulates the processing acc. to the order set in the NC program
- Allows time calculation

## ADDITIONAL SOFTWARE

1. woodWOP Office
2. 3D CNC-Simulator
3. woodAssembler



Package

# Easy to get. And easy to use.

## tapio is the open wood industry ecosystem

This means that everyone involved in the wood industry can participate.  
Because together with our business partners, we develop digital solutions for everyone.



### Just have a try:

Free use of the MachineBoard app! Just register under tapio and “connect” the machine [www.tapio.one](http://www.tapio.one). The complimentary usage is limited in time.



# Apps that make working life easier.

# tapio

Partner

## DataSave

- Protects machine and configuration expertise
- Faster service for machine breakdowns
- Saves time when restarting production
- Saves on maintenance costs
- Automatic backups of several machines

## ServiceBoard

- Create service cases quickly and easily and send them to the correct service partner
- Live video diagnostics to solve service cases with image support
- Video reduces the language and distance barriers
- Also works without a machine connection to tapio (and is therefore ideal for older machines)

## MachineBoard

- Push notifications
- Machine data and status can be viewed from anywhere in real time
- Lists of errors, warnings, maintenance tasks and actions
- Displays the remaining time until the next intervention by the machine operator



**Free demo for all tapio apps, no registration required. Simply download and test.**

Currently available in the EU and Switzerland.

(Due to the fast pace of the IT-landscape, the compatibility to the tapio platform is warranted for five years.)



For you more than...

**1,350**

service employees worldwide

**90 %**

less on-site service thanks to successful remote diagnosis

**5,000**

customer training sessions per / year

**150,000**

machines, all electronically documented in 28 different languages – in eParts

## **HC** LIFE CYCLE SERVICES

Optimal service and individual consultations are included in the purchase of our machines. We support you with service innovations and products which are especially tailored to your requirements. With short response times and fast

customer solutions we guarantee consistently high availability and economical production – over the entire life cycle of your machine.



### REMOTE SERVICE

- Hotline support via remote diagnosis by our trained experts regarding control, mechanics and process technology. Thus, more than 90 % less on-site service required and consequently a faster solution for you!
- The ServiceBoard App helps to solve tasks in a fast, simple and concrete way. This is achieved by mobile live video diagnosis, automatic sending of service requests or the online spare parts catalog eParts.



### SPARE PARTS SERVICE

- High spare parts availability and fast delivery.
- Ensuring quality by predefined spare parts and wear parts kits, comprising original spare parts.
- Identify and inquire for spare parts online under [www.eParts.de](http://www.eParts.de) 24/7, or buy even faster and more comfortably in the new HOMAG Webshop eCommerce.



### FIELD SERVICE

- Increased machine availability and product quality by certified service staff.
- Regular checks through maintenance / inspection guarantee the highest quality of your products.
- We offer you the highest availability of technicians in order to reduce downtimes in case of unpredictable troubles.

# Technical Data



Dimensions in mm

\* A corresponding safety distance must be maintained in the in and outfeed direction! (See documentation)

TECHNICAL DATA			
Workpiece dimensions max.	L x W x T	mm	2,500 x 850 x 60 / optional 3,050
Workpiece dimensions min.	L x W x T	mm	200 x 70 x 12
Vector speed		m/min	(X - Y) 50 - (Z) 15
Compressed air required		bar	7
Compressed air connection		inch	R 1/2
Dust extraction port		mm	Ø 160
Dust extraction volume		m <sup>3</sup> /h	min. 2,170
Electrical power – total connection load		kW	11,5
Total machine weight		kg	approx. 1,580

## **HOMAG Group AG**

info@homag.com

www.homag.com



## **YOUR SOLUTION**