



Evolved **Experience**



Ricambi Spare parts

Ricambi Spare parts

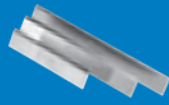

Coltelli pialla P 449
Plaining knives

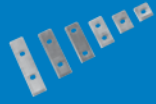

Coltelli standard P 457
Standard knives



Coltelli sagomati P 464
Shaped knives

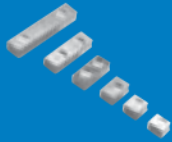

Lardoni di serraggio P 486
Clamping wedge



Viti di fissaggio P 487
Fixing screws

Coltelli pialla spessore 3mm.

Planing knives with thickness of 3mm.

Couteaux pour rabots avec epaisseur de 3mm.

Strefenhobelmesser 3mm.

Cuchillas para cepillar 3mm.

Altezza 25mm

Height 25 mm

B	H	S	HSS (13% Cr)	HSS (18% W)	HM
			ID nr.	ID nr.	ID nr.
120	25	3	9501 053/25	9501 003/25	9501 103/25
190	25	3	9501 060/25	9501 010/25	9501 110/25

Altezza 30mm

Height 30 mm

B	H	S	HSS (13% Cr)	HSS (18% W)	HM
			ID nr.	ID nr.	ID nr.
60	30	3	9501 084/30	9501 034/30	9501 134/30
80	30	3	9501 051/30	9501 001/30	9501 101/30
100	30	3	9501 052/30	9501 002/30	9501 102/30
120	30	3	9501 053/30	9501 003/30	9501 103/30
130	30	3	9501 054/30	9501 004/30	9501 104/30
140	30	3	9501 055/30	9501 005/30	9501 105/30
150	30	3	9501 056/30	9501 006/30	9501 106/30
160	30	3	9501 057/30	9501 007/30	9501 107/30
170	30	3	9501 058/30	9501 008/30	9501 108/30
180	30	3	9501 059/30	9501 009/30	9501 109/30
190	30	3	9501 060/30	9501 010/30	9501 110/30
200	30	3	9501 061/30	9501 011/30	9501 111/30
210	30	3	9501 062/30	9501 012/30	9501 112/30
220	30	3	9501 063/30	9501 013/30	9501 113/30
230	30	3	9501 064/30	9501 014/30	9501 114/30
240	30	3	9501 065/30	9501 015/30	9501 115/30
245	30	3	9501 066/30	9501 016/30	9501 116/30
250	30	3	9501 067/30	9501 017/30	9501 117/30
260	30	3	9501 085/30	9501 035/30	9501 135/30
300	30	3	9501 068/30	9501 018/30	9501 118/30
350	30	3	9501 069/30	9501 019/30	9501 119/30
400	30	3	9501 070/30	9501 020/30	9501 120/30
410	30	3	9501 071/30	9501 021/30	9501 121/30
430	30	3	9501 072/30	9501 022/30	9501 122/30
500	30	3	9501 073/30	9501 023/30	9501 123/30
510	30	3	9501 074/30	9501 024/30	9501 124/30
520	30	3	9501 075/30	9501 025/30	9501 125/30
530	30	3	9501 076/30	9501 026/30	9501 126/30
600	30	3	9501 077/30	9501 027/30	9501 127/30
610	30	3	9501 078/30	9501 028/30	9501 128/30
630	30	3	9501 079/30	9501 029/30	9501 129/30
640	30	3	9501 080/30	9501 030/30	9501 130/30
700	30	3	9501 139/30	9501 136/30	9501 142/30
710	30	3	9501 081/30	9501 031/30	9501 131/30
800	30	3	9501 140/30	9501 137/30	9501 143/30
810	30	3	9501 082/30	9501 032/30	9501 132/30
1080	30	3	9501 083/30	9501 033/30	9501 133/30

9501

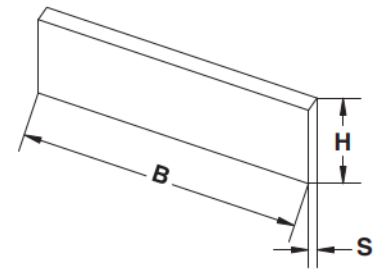

9501

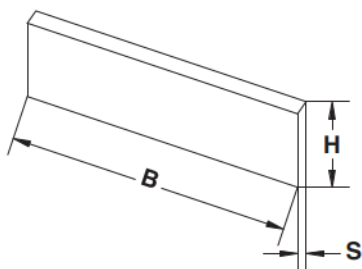

Coltelli pialla spessore 3mm.
Plating knives with thickness of 3mm.
 Couteaux pour rabots avec epaisseur de 3mm.
 Strefenhobelmesser 3mm.
 Cuchillas para cepillar 3mm.

Altezza 35mm
 Height 35 mm

B	H	S	HSS (13% Cr)	HSS (18% W)	HM
			ID nr.	ID nr.	ID nr.
60	35	3	9501 084/35	9501 034/35	9501 134/35
80	35	3	9501 051/35	9501 001/35	9501 101/35
100	35	3	9501 052/35	9501 002/35	9501 102/35
120	35	3	9501 053/35	9501 003/35	9501 103/35
130	35	3	9501 054/35	9501 004/35	9501 104/35
140	35	3	9501 055/35	9501 005/35	9501 105/35
150	35	3	9501 056/35	9501 006/35	9501 106/35
160	35	3	9501 057/35	9501 007/35	9501 107/35
170	35	3	9501 058/35	9501 008/35	9501 108/35
180	35	3	9501 059/35	9501 009/35	9501 109/35
190	35	3	9501 060/35	9501 010/35	9501 110/35
200	35	3	9501 061/35	9501 011/35	9501 111/35
210	35	3	9501 062/35	9501 012/35	9501 112/35
220	35	3	9501 063/35	9501 013/35	9501 113/35
230	35	3	9501 064/35	9501 014/35	9501 114/35
240	35	3	9501 065/35	9501 015/35	9501 115/35
245	35	3	9501 066/35	9501 016/35	9501 116/35
250	35	3	9501 067/35	9501 017/35	9501 117/35
260	35	3	9501 085/35	9501 035/35	9501 135/35
300	35	3	9501 068/35	9501 018/35	9501 118/35
350	35	3	9501 069/35	9501 019/35	9501 119/35
400	35	3	9501 070/35	9501 020/35	9501 120/35
410	35	3	9501 071/35	9501 021/35	9501 121/35
430	35	3	9501 072/35	9501 022/35	9501 122/35
500	35	3	9501 073/35	9501 023/35	9501 123/35
510	35	3	9501 074/35	9501 024/35	9501 124/35
520	35	3	9501 075/35	9501 025/35	9501 125/35
530	35	3	9501 076/35	9501 026/35	9501 126/35
600	35	3	9501 077/35	9501 027/35	9501 127/35
610	35	3	9501 078/35	9501 028/35	9501 128/35
630	35	3	9501 079/35	9501 029/35	9501 129/35
640	35	3	9501 080/35	9501 030/35	9501 130/35
700	35	3	9501 139/35	9501 136/35	9501 142/35
710	35	3	9501 081/35	9501 031/35	9501 131/35
800	35	3	9501 140/35	9501 137/35	9501 143/35
810	35	3	9501 082/35	9501 032/35	9501 132/35
1080	35	3	9501 083/35	9501 033/35	9501 133/35

Coltelli rigati da sagomare in HSS.

Knives to profile in HSS.

Couteaux à profiler en HSS.

Messern zu profilieren in HSS.

Cuchillas currugadas en HSS por perfilar.

9502

B	H	P	S	ID nr.
40	50	18	8	9502 001
50	50	18	8	9502 002
60	50	18	8	9502 003
80	50	18	8	9502 004
100	50	18	8	9502 005
130	50	18	8	9502 006
150	50	18	8	9502 007
180	50	18	8	9502 008
230	50	18	8	9502 009
650	50	18	8	9502 010
40	60	28	8	9502 011
50	60	28	8	9502 012
60	60	28	8	9502 013
80	60	28	8	9502 014
100	60	28	8	9502 015
130	60	28	8	9502 016
150	60	28	8	9502 017
180	60	28	8	9502 018
230	60	28	8	9502 019
650	60	28	8	9502 020
40	70	38	8	9502 021
50	70	38	8	9502 022
60	70	38	8	9502 023
80	70	38	8	9502 024
100	70	38	8	9502 025
130	70	38	8	9502 026
150	70	38	8	9502 027
180	70	38	8	9502 028
230	70	38	8	9502 029
650	70	38	8	9502 030

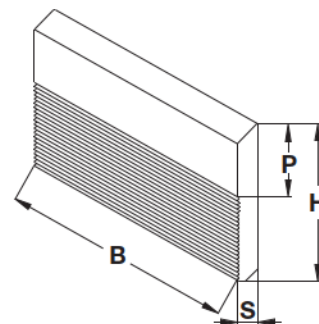

9502a

Coltelli rigati sagomati in HSS.

Profiled knives in HSS.

Couteaux profilés en HSS.

Profilierten Messern in HSS.

Cuchillas corrugadas perfiladas en HSS.

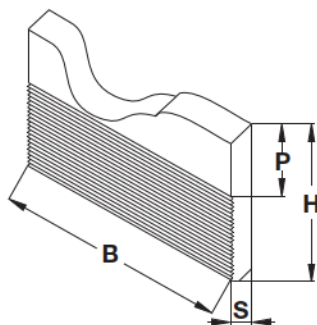

B	H	P	S	ID nr.
40	50	18	8	9502 301
50	50	18	8	9502 302
60	50	18	8	9502 303
80	50	18	8	9502 304
100	50	18	8	9502 305
130	50	18	8	9502 306
150	50	18	8	9502 307
180	50	18	8	9502 308
230	50	18	8	9502 309
40	60	28	8	9502 310
50	60	28	8	9502 311
60	60	28	8	9502 312
80	60	28	8	9502 313
100	60	28	8	9502 314
130	60	28	8	9502 315
150	60	28	8	9502 316
180	60	28	8	9502 317
230	60	28	8	9502 318
40	70	38	8	9502 319
50	70	38	8	9502 320
60	70	38	8	9502 321
80	70	38	8	9502 322
100	70	38	8	9502 323
130	70	38	8	9502 324
150	70	38	8	9502 325
180	70	38	8	9502 326
230	70	38	8	9502 327

Coltelli pialla per sistema "Tersa".

System "Tersa" Planer knives.

Systemhobelmesser "Tersa".

Couteaux à raboter pour système "Tersa".

Cuchillas para cepillar para sistema "Tersa".

9577

B	H	S	HSS (13% Cr)	HSS (18% W)	HM
			ID nr.	ID nr.	ID nr.
60	10	2,3	9577001	9577101	9577201
75	10	2,3	9577002	9577102	9577202
80	10	2,3	9577003	9577103	9577203
90	10	2,3	9577004	9577104	9577204
95	10	2,3	9577005	9577105	9577205
100	10	2,3	9577006	9577106	9577206
110	10	2,3	9577007	9577107	9577207
115	10	2,3	9577008	9577108	9577208
120	10	2,3	9577009	9577109	9577209
125	10	2,3	9577010	9577110	9577210
130	10	2,3	9577011	9577111	9577211
135	10	2,3	9577012	9577112	9577212
140	10	2,3	9577013	9577113	9577213
145	10	2,3	9577014	9577114	9577214
150	10	2,3	9577015	9577115	9577215
160	10	2,3	9577016	9577116	9577216
170	10	2,3	9577017	9577117	9577217
180	10	2,3	9577018	9577118	9577218
185	10	2,3	9577019	9577119	9577219
190	10	2,3	9577020	9577120	9577220
200	10	2,3	9577021	9577121	9577221
210	10	2,3	9577022	9577122	9577222
220	10	2,3	9577023	9577123	9577223
230	10	2,3	9577024	9577124	9577224
235	10	2,3	9577025	9577125	9577225
240	10	2,3	9577026	9577126	9577226
250	10	2,3	9577027	9577127	9577227
260	10	2,3	9577028	9577128	9577228
265	10	2,3	9577029	9577129	9577229
270	10	2,3	9577030	9577130	9577230
280	10	2,3	9577031	9577131	9577231
300	10	2,3	9577032	9577132	9577232
310	10	2,3	9577033	9577133	9577233
320	10	2,3	9577034	9577134	9577234
330	10	2,3	9577035	9577135	9577235
350	10	2,3	9577036	9577136	9577236
360	10	2,3	9577037	9577137	9577237
400	10	2,3	9577038	9577138	9577238
410	10	2,3	9577039	9577139	9577239
415	10	2,3	9577040	9577140	9577240
420	10	2,3	9577041	9577141	9577241
430	10	2,3	9577042	9577142	9577242
450	10	2,3	9577043	9577143	9577243
500	10	2,3	9577044	9577144	9577244
510	10	2,3	9577045	9577145	9577245
520	10	2,3	9577046	9577146	9577246
530	10	2,3	9577047	9577147	9577247
540	10	2,3	9577048	9577148	9577248
600	10	2,3	9577049	9577149	9577249
610	10	2,3	9577050	9577150	9577250
630	10	2,3	9577051	9577151	9577251
635	10	2,3	9577052	9577152	9577252
640	10	2,3	9577053	9577153	9577253
650	10	2,3	9577054	9577154	9577254
710	10	2,3	9577055	9577155	9577255
810	10	2,3	9577056	9577156	9577256
1050	10	2,3	9577057	9577157	9577257

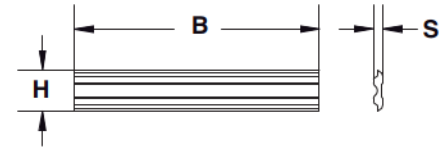

9578

Coltelli pialla per sistema "Centrolock".
System "Centrolock" Planer knives.
Systemhobelmesser "Centrolock".
Couteaux à raboter pour système "Centrolock".
Cuchillas para cepillar para sistema "Centrolock".

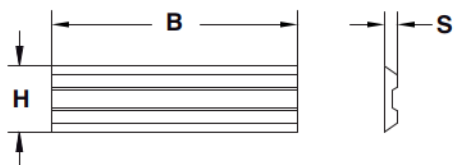

B	H	S	HSS (13% Cr)	HSS (18% W)	HM
			ID nr.	ID nr.	ID nr.
10	16	3	9578 001	9578 101	9578 201
20	16	3	9578 002	9578 102	9578 202
30	16	3	9578 003	9578 103	9578 203
40	16	3	9578 004	9578 104	9578 204
50	16	3	9578 005	9578 105	9578 205
60	16	3	9578 006	9578 106	9578 206
65	16	3	9578 007	9578 107	9578 207
80	16	3	9578 008	9578 108	9578 208
100	16	3	9578 009	9578 109	9578 209
115	16	3	9578 010	9578 110	9578 210
130	16	3	9578 011	9578 111	9578 211
140	16	3	9578 012	9578 112	9578 212
150	16	3	9578 013	9578 113	9578 213
160	16	3	9578 014	9578 114	9578 214
170	16	3	9578 015	9578 115	9578 215
180	16	3	9578 016	9578 116	9578 216
190	16	3	9578 017	9578 117	9578 217
210	16	3	9578 018	9578 118	9578 218
220	16	3	9578 019	9578 119	9578 219
230	16	3	9578 020	9578 120	9578 220
235	16	3	9578 021	9578 121	9578 221
240	16	3	9578 022	9578 122	9578 222
260	16	3	9578 023	9578 123	9578 223
270	16	3	9578 024	9578 124	9578 224
300	16	3	9578 025	9578 125	9578 225
310	16	3	9578 026	9578 126	9578 226
460	16	3	9578 027	9578 127	9578 227
650	16	3	9578 028	9578 128	9578 228
710	16	3	9578 029	9578 129	9578 229
810	16	3	9578 030	9578 130	9578 230
1050	16	3	9578 031	9578 131	9578 231

Coltelli pialla per sistema "Terminus".

System "Terminus" Planer knives.

Systemhobelmesser "Terminus".

Couteaux à raboter pour système "Terminus".

Cuchillas para cepillar para sistema "Terminus".

9579

B	H	S	HSS (13% Cr)	HSS (18% W)	HM
			ID nr.	ID nr.	ID nr.
50	14	2,55	9579 001	9579 101	9579 201
60	14	2,55	9579 002	9579 102	9579 202
80	14	2,55	9579 003	9579 103	9579 203
100	14	2,55	9579 004	9579 104	9579 204
110	14	2,55	9579 005	9579 105	9579 205
120	14	2,55	9579 006	9579 106	9579 206
130	14	2,55	9579 007	9579 107	9579 207
136	14	2,55	9579 008	9579 108	9579 208
140	14	2,55	9579 009	9579 109	9579 209
150	14	2,55	9579 010	9579 110	9579 210
160	14	2,55	9579 011	9579 111	9579 211
170	14	2,55	9579 012	9579 112	9579 212
180	14	2,55	9579 013	9579 113	9579 213
190	14	2,55	9579 014	9579 114	9579 214
200	14	2,55	9579 015	9579 115	9579 215
210	14	2,55	9579 016	9579 116	9579 216
220	14	2,55	9579 017	9579 117	9579 217
230	14	2,55	9579 018	9579 118	9579 218
240	14	2,55	9579 019	9579 119	9579 219
250	14	2,55	9579 020	9579 120	9579 220
255	14	2,55	9579 021	9579 121	9579 221
260	14	2,55	9579 022	9579 122	9579 222
270	14	2,55	9579 023	9579 123	9579 223
275	14	2,55	9579 024	9579 124	9579 224
280	14	2,55	9579 025	9579 125	9579 225

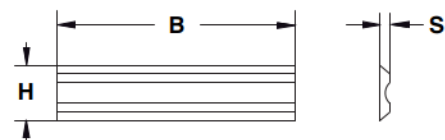

9580

Coltelli pialla per sistema "Centrofix/Centrostar/Quickfix".
System "Centrofix/Centrostar/Quickfix" Planer knives .
Systemhobelmesser "Centrofix/Centrostar/Quickfix".
Couteaux à raboter pour système "Centrofix/Centrostar/Quickfix".
Cuchillas para cepillar para sistema "Centrofix/Centrostar/Quickfix".

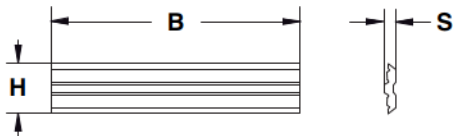

HSS (13% Cr) HSS (18% W) HM

B	H	S	ID nr.	ID nr.	ID nr.
50	12	2,7	9580 001	9580 101	9580 201
80	12	2,7	9580 002	9580 102	9580 202
100	12	2,7	9580 003	9580 103	9580 203
120	12	2,7	9580 004	9580 104	9580 204
130	12	2,7	9580 005	9580 105	9580 205
136	12	2,7	9580 006	9580 106	9580 206
150	12	2,7	9580 007	9580 107	9580 207
170	12	2,7	9580 008	9580 108	9580 208
180	12	2,7	9580 009	9580 109	9580 209
190	12	2,7	9580 010	9580 110	9580 210
210	12	2,7	9580 011	9580 111	9580 211
230	12	2,7	9580 012	9580 112	9580 212
240	12	2,7	9580 013	9580 113	9580 213
310	12	2,7	9580 014	9580 114	9580 214
400	12	2,7	9580 015	9580 115	9580 215
410	12	2,7	9580 016	9580 116	9580 216
420	12	2,7	9580 017	9580 117	9580 217
430	12	2,7	9580 018	9580 118	9580 218
500	12	2,7	9580 019	9580 119	9580 219
510	12	2,7	9580 020	9580 120	9580 220
520	12	2,7	9580 021	9580 121	9580 221
530	12	2,7	9580 022	9580 122	9580 222
540	12	2,7	9580 023	9580 123	9580 223
630	12	2,7	9580 024	9580 124	9580 224
640	12	2,7	9580 025	9580 125	9580 225
650	12	2,7	9580 026	9580 126	9580 226
710	12	2,7	9580 027	9580 127	9580 227
810	12	2,7	9580 028	9580 128	9580 228
1050	12	2,7	9580 029	9580 129	9580 229

Coltelli in HM integrale per sistema Bulldozer di ricambio per art. 2074.

Knives in HM integral for Bulldozer system for art. 2074.

Couteaux en HM intégral pour le système Bulldozer pour art. 2074.

Messern aus HM integral für Bulldozer System für art. 2074.

Cuchillas en HM macizo para el sistema Bulldozer como repuestos del art. 2074.

B	H	S	ID nr.
60	13,6	1,8	9565 008
70	13,6	1,8	9565 009
80	13,6	1,8	9565 001
100	13,6	1,8	9565 002
110	13,6	1,8	9565 010
120	13,6	1,8	9565 003
130	13,6	1,8	9565 011
140	13,6	1,8	9565 012
150	13,6	1,8	9565 013
160	13,6	1,8	9565 014
180	13,6	1,8	9565 015
184	13,6	1,8	9565 004
190	13,6	1,8	9565 016
200	13,6	1,8	9565 017
220	13,6	1,8	9565 005
230	13,6	1,8	9565 006
240	13,6	1,8	9565 018
250	13,6	1,8	9565 007
260	13,6	1,8	9565 019

9565

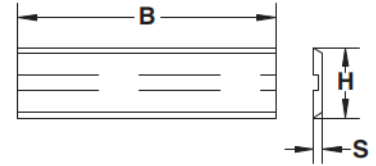

Coltellini a gettare in HM integrale.

Reversible HM integral knives.

Couteaux reversibles en HM intégral.

Messe zu HM integral Werfen.

Cuchillas de usar y tirar en HM macizo.

B	H	S	b	β	ID nr.
7,65	12	1,5	-	35°	9503 001
9,65	12	1,5	-	35°	9503 002
12	12	1,5	-	35°	9503 003
15	12	1,5	-	35°	9503 004
20	12	1,5	-	35°	9503 005
30	12	1,5	14	35°	9503 006
40	12	1,5	26	35°	9503 007
50	12	1,5	26	35°	9503 008
60	12	1,5	26	35°	9503 009
80	13	2,2	60	35°	9503 010
100	13	2,2	60	35°	9503 011
120	13	2,2	60	35°	9503 012

9503

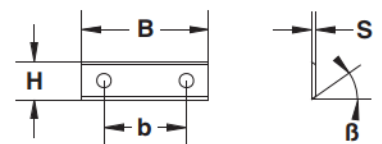

9504

Coltellini a gettare in HM integrale con spoglia a 45°.

Reversible HM integral knives with rake of 45°.

Couteaux reversibles en HM intégral avec depouille à 45°.

Messe zu HM integral Werfen mit Balg 45°.

Cuchillas de usar y tirar en HM macizo con corte inclinado a 45°.

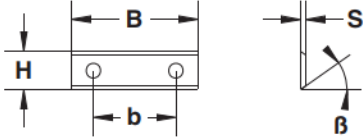

B	H	S	b	β	ID nr.
7,65	12	1,5	-	45°	9504 001
12	12	1,5	-	45°	9504 002
15	12	1,5	-	45°	9504 003
20	12	1,5	-	45°	9504 004
30	12	1,5	14	45°	9504 005
40	12	1,5	26	45°	9504 006
50	12	1,5	26	45°	9504 007
60	12	1,5	26	45°	9504 008

9505

Coltellini a gettare in HM integrale KCR08.

Reversible HM integral knives KCR08.

Couteaux reversibles en HM intégral KCR08.

Messe zu HM integral Werfen KCR08.

Cuchillas de usar y tirar en HM macizo KCR08.

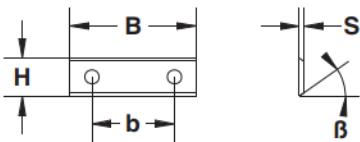

B	H	S	b	β	ID nr.
20	12	1,5	-	35°	9505 001
30	12	1,5	14	35°	9505 002
50	12	1,5	26	35°	9505 003

Coltellini a gettare in HM integrale altezza 9mm.
Reversible HM integral knives with height of 9mm.
 Couteaux reversibles en HM intégral avec hauteur de 9mm.
Messe zu HM integral Werfen mit Höhe 9mm.
 Cuchillas de usar y tirar en HM macizo altas 9mm.

9506

B	H	S	β	ID nr.
7,5	9	1,5	35°	9506 001
9,6	9	1,5	35°	9506 002
12	9	1,5	35°	9506 003
14,6	9	1,5	35°	9506 004
20	9	1,5	35°	9506 005
30	9	1,5	35°	9506 006
40	9	1,5	35°	9506 007
50	9	1,5	35°	9506 008
60	9	1,5	35°	9506 009

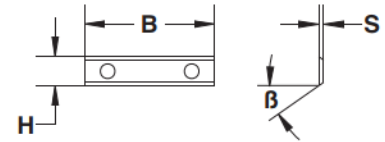

Mini-coltellini a gettare in HM integrale.
Reversible HM integral mini-knives.
 Mini-couteaux reversibles en HM intégral.
Zeitung Hebelkante zu HM integral.
 Mini cuchillas de usar y tirar en HM macizo.

9507

B	H	S	β	ID nr.
12	5,5	1,1	35°	9507 001
20	5,5	1,1	35°	9507 002
30	5,5	1,1	35°	9507 003
40	5,5	1,1	35°	9507 004
50	5,5	1,1	35°	9507 005

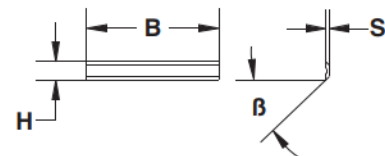

Mini-coltellini a gettare in HM integrale.
Reversible HM integral mini-knives.
 Mini-couteaux reversibles en HM intégral.
Zeitung Hebelkante zu HM integral.
 Mini cuchillas de usar y tirar en HM macizo.

9507a

B	H	S	β	ID nr.
82	5,5	1,1	35°	9507 051

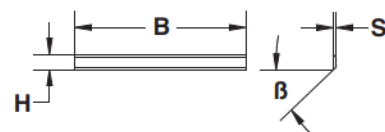

9508

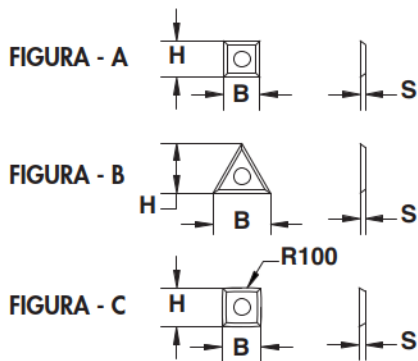

Rasanti in HM integrale.
Reversible HM integral trimmers.
 Rasant en HM intégral.
Vorschneider zu HM integral.
 Cuchillas ralladoras en HM macizo.

B	H	S	FIGURA	ID nr.
14	14	1,2	A	9508 001
14	14	2	A	9508 002
22	19	2	B	9508 003
15	15	2,5	C	9508 011

9509

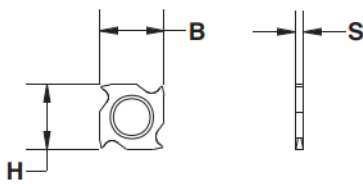

Rosette per teste incastrati in HM integrale.
Reversible HM integral knives for groove cutter heads.
 Couteaux pour têtes encastrement en HM intégral.
Messer für kopf einschnitt zu HM integral.
 Cuchillas ralladoras para ensambles en HM macizo.

B	H	S	ID nr.
18	18	1,95	9509 001
18	18	2,95	9509 002

9510

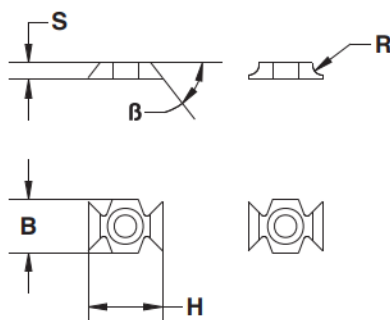

Inserti levaspiglioli in HM integrale.
All-HM integral beveller inserts.
 Insertions leve-angles en HM intégral.
Zeitung Hebelkante zu HM integral.
 Chafanadores en HM macizo.

B	H	S	β	RAGGIO	ID nr.
16	22	5	45°	-	9510 001
16	22	5	-	R1,5	9510 002
16	22	5	-	R2	9510 003
16	22	5	-	R3	9510 004
16	22	5	-	R4	9510 005
16	22	5	-	R5	9510 006

Inserti levaspigoli in HM integrale tagliati.
All-HM integral beveller inserts.
 Insertions leve-angles en HM intégral.
Zeitung Hebelkante zu HM integral.
 Chafflanadores en HM macizo cortados.

B	H	S	RAGGIO	ID nr.
16	16,5	5	45°	9511 001
16	16,5	5	-	9511 002
16	16,5	5	-	9511 003
16	16,5	5	-	9511 004
16	16,5	5	-	9511 005
16	16,5	5	-	9511 006

9511

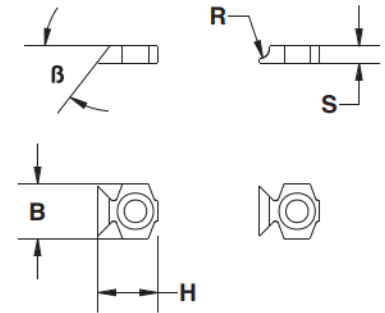

Inserti per canali in HM integrale.
Inserts in HM integral for gasket groove.
 Insertion en HM intégral pour rainure joint.
Zeitung zu HM integral für Rohr besatz.
 Cuchillas para ranuras en HM macizo.

BxHxS	ID nr.
16x29x4	9512 001
16x29x5	9512 002
16x29x6	9512 003

9512

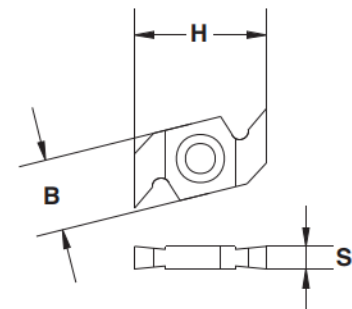

Inserti per canali saldobrasati in HM integrale.
All-HM integral inserts.
 Outils en HM intégral.
Zeitung zu HM integral.
 Cuchillas para ranuras con dientes soldados en HM macizo.

B	ID nr.	ID nr.
16x32,5x3	9513 051	9513 052
16x32,5x4	9513 053	9513 054
16x32,5x5	9513 055	9513 056
16x32,5x6	9513 057	9513 058
16x32,5x7	9513 059	9513 060

9513

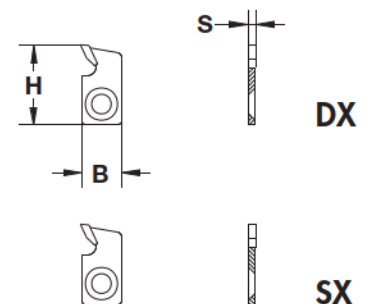

9514

TIPO - A

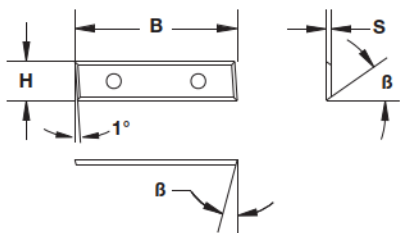

TIPO - B

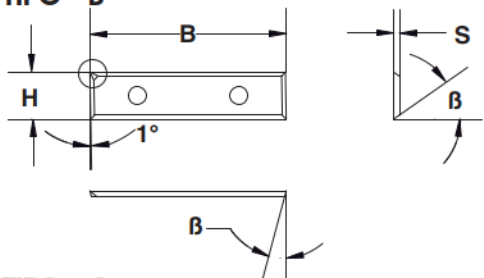

TIPO - C

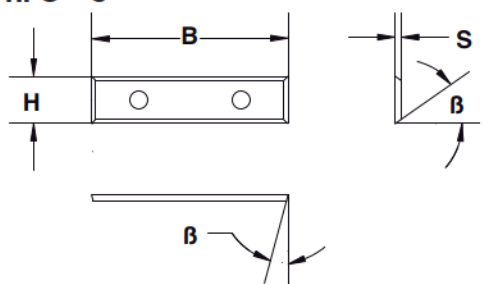

Coltellini a gettare con taglio in testa in HM integrale.

Reversible HM integral knives.

Couteaux reversibles en HM intégral.

Messe zu HM integral Werfen.

Cuchillas de usar y tirar con los cuatro lados cortantes en HM macizo.

COLTELLI CON TAGLIO LATERALE INCLINATO 1°.
KNIVES WITH INCLINED AT 1° LATERAL CUTTING.

B	H	S	TIPO	B	ID nr.
30	12	1,5	A	35°	9514 001
50	12	1,5		35°	9514 002
30	9	1,5		35°	9514 011
50	9	1,5		35°	9514 012

COLTELLI CON TAGLIO LATERALE INCLINATO 1° E DOPPIO SCARTO SUL DORSO.
KNIVES WITH INCLINED AT 1° LATERAL CUTTING AND DOUBLE BACK GRINDING.
DI RICAMBIO PER ART. 3072 / SPARE KNIVES FOR ART. 3072

B	H	S	TIPO	B	ID nr.
30	12	1,5	B	35°	9514 021
50	12	1,5		35°	9514 022
60	12	1,5		35°	9514 023

COLTELLI RETTANGOLARI CON TAGLIO SU 4 LATI.
RECTANGULAR KNIVES WITH 4 SIDES CUTTING.
DI RICAMBIO PER ART. 3038 / SPARE KNIVES FOR ART. 3038

B	H	S	TIPO	B	ID nr.
30	12	1,5	C	35°	9514 051
40	12	1,5		35°	9514 052
50	12	1,5		35°	9514 053

9515

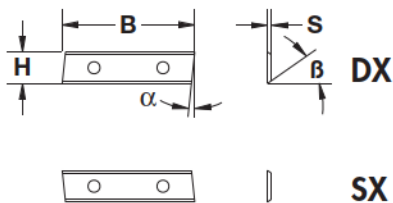

Coltellini a gettare inclinati lateralmente in HM integrale.

Reversible HM integral knives.

Couteaux reversibles en HM intégral.

Messe zu HM integral Werfen.

Cuchillas de usar y tirar con dos lados inclinados en HM macizo.

BxHxS	α	B	ID nr. DX	ID nr. SX
7,5x12x1,5	6°	35°	9515 001	9515 002
9,65x12x1,5	6°	35°	9515 003	9515 004
12x12x1,5	6°	35°	9515 005	9515 006
15x12x1,5	6°	35°	9515 007	9515 008
20x12x1,5	6°	35°	9515 009	9515 010
30x12x1,5	6°	35°	9515 011	9515 012
40x12x1,5	6°	35°	9515 013	9515 014
50x12x1,5	6°	35°	9515 015	9515 016
7,5x12x1,5	12°	35°	9515 051	9515 052
9,65x12x1,5	12°	35°	9515 053	9515 054
12x12x1,5	12°	35°	9515 055	9515 056
15x12x1,5	12°	35°	9515 057	9515 058
20x12x1,5	12°	35°	9515 059	9515 060
30x12x1,5	12°	35°	9515 061	9515 062
40x12x1,5	12°	35°	9515 063	9515 064
50x12x1,5	12°	35°	9515 065	9515 066

Coltellini a gettare in HM integrale inclinati lateralmente con spoglia a 45°.

Reversible HM integral knives with rake of 45°.

Couteaux reversibles en HM intégral avec depouille à 45°.

Messe zu HM integral Werfen mit Balg 45°.

Cuchillas de usar y tirar en HM macizo con dos lados inclinados y con radio a 45°

BxHxS	α	β	ID nr. DX	ID nr. SX
7,5x12x1,5	6°	45°	9516 001	9516 002
15x12x1,5	6°	45°	9516 005	9516 006
20x12x1,5	6°	45°	9516 007	9516 008
30x12x1,5	6°	45°	9516 009	9516 010
40x12x1,5	6°	45°	9516 011	9516 012
50x12x1,5	6°	45°	9516 013	9516 014
7,5x12x1,5	12°	45°	9516 051	9516 052
15x12x1,5	12°	45°	9516 055	9516 056
20x12x1,5	12°	45°	9516 057	9516 058
30x12x1,5	12°	45°	9516 059	9516 060
40x12x1,5	12°	45°	9516 061	9516 062
50x12x1,5	12°	45°	9516 063	9516 064

Coltellini a gettare in HM integrale affilati a botte.

Reversible HM integral knives bevelled in 4 sides.

Couteaux reversibles en HM intégral émoussés sur 4 côtés.

Messe zu HM integral stumpf auf 4 Seiten.

Cuchillas de usar y tirar en HM macizo con corte chafflanado.

B	H	S	β	ID nr.
30	12	1,5	35°	9517 001
40	12	1,5	35°	9517 002
30	12	1,5	45°	9517 051

Coltellino in HM integrale con rompitruciolo.

Knife HM integral with chipbreaker.

Couteau en HM intégral avec brisecoupeau.

Messe zu HM integral mit Spanbrecher.

Cuchilla en HM macizo con rompevirutas.

B	H	S	ID nr.
15	15	2	9518 001

9516

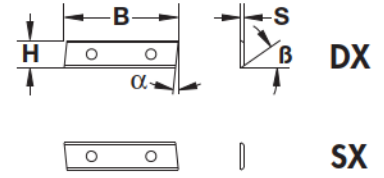

9517

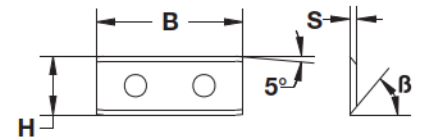

9518

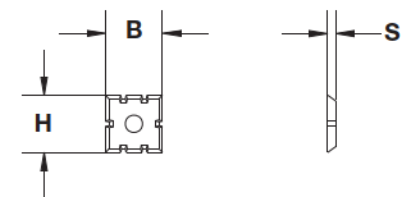

9519

Coltelli sagomati di ricambio in HM integrale.

Profiled spare knives HM integral.

Couteaux profilés de rechange en HM intégral.

Messern mit Profil zu HM integral.

Cuchillas perfiladas utilizadas como repuestos en HM macizo.

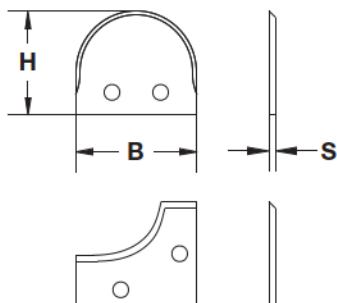

Dimensioni		ID nr.					
BxHxS	n°6 pz	n°12 pz	n°24 pz	n°36 pz	n°60 pz	n°90 pz	
20x20x2	9519001	9519001/A	9519001/B	9519001/C	9519001/D	9519001/E	
20x25x2	9519002	9519002/A	9519002/B	9519002/C	9519002/D	9519002/E	
20x30x2	9519003	9519003/A	9519003/B	9519003/C	9519003/D	9519003/E	
20x35x2	9519004	9519004/A	9519004/B	9519004/C	9519004/D	9519004/E	
25x20x2	9519005	9519005/A	9519005/B	9519005/C	9519005/D	9519005/E	
25x25x2	9519006	9519006/A	9519006/B	9519006/C	9519006/D	9519006/E	
25x30x2	9519007	9519007/A	9519007/B	9519007/C	9519007/D	9519007/E	
25x35x2	9519008	9519008/A	9519008/B	9519008/C	9519008/D	9519008/E	
30x20x2	9519009	9519009/A	9519009/B	9519009/C	9519009/D	9519009/E	
30x25x2	9519010	9519010/A	9519010/B	9519010/C	9519010/D	9519010/E	
30x30x2*	9519011	9519011/A	9519011/B	9519011/C	9519011/D	9519011/E	
30x35x2	9519012	9519012/A	9519012/B	9519012/C	9519012/D	9519012/E	
30x40x2	9519013	9519013/A	9519013/B	9519013/C	9519013/D	9519013/E	
35x25x2	9519014	9519014/A	9519014/B	9519014/C	9519014/D	9519014/E	
35x30x2*	9519015	9519015/A	9519015/B	9519015/C	9519015/D	9519015/E	
35x35x2*	9519016	9519016/A	9519016/B	9519016/C	9519016/D	9519016/E	
35x40x2	9519017	9519017/A	9519017/B	9519017/C	9519017/D	9519017/E	
40x20x2	9519018	9519018/A	9519018/B	9519018/C	9519018/D	9519018/E	
40x25x2	9519019	9519019/A	9519019/B	9519019/C	9519019/D	9519019/E	
40x30x2*	9519020	9519020/A	9519020/B	9519020/C	9519020/D	9519020/E	
40x35x2*	9519021	9519021/A	9519021/B	9519021/C	9519021/D	9519021/E	
40x40x2*	9519022	9519022/A	9519022/B	9519022/C	9519022/D	9519022/E	
50x25x2	9519023	9519023/A	9519023/B	9519023/C	9519023/D	9519023/E	
50x30x2	9519024	9519024/A	9519024/B	9519024/C	9519024/D	9519024/E	
50x35x2	9519025	9519025/A	9519025/B	9519025/C	9519025/D	9519025/E	
50x40x2	9519026	9519026/A	9519026/B	9519026/C	9519026/D	9519026/E	
50x45x2	9519027	9519027/A	9519027/B	9519027/C	9519027/D	9519027/E	
60x30x2	9519028	9519028/A	9519028/B	9519028/C	9519028/D	9519028/E	
60x35x2	9519029	9519029/A	9519029/B	9519029/C	9519029/D	9519029/E	
60x40x2	9519030	9519030/A	9519030/B	9519030/C	9519030/D	9519030/E	
80x30x2	9519031	9519031/A	9519031/B	9519031/C	9519031/D	9519031/E	
80x35x2	9519032	9519032/A	9519032/B	9519032/C	9519032/D	9519032/E	
80x40x2	9519033	9519033/A	9519033/B	9519033/C	9519033/D	9519033/E	
100x30x2	9519034	9519034/A	9519034/B	9519034/C	9519034/D	9519034/E	
100x35x2	9519035	9519035/A	9519035/B	9519035/C	9519035/D	9519035/E	
100x40x2	9519036	9519036/A	9519036/B	9519036/C	9519036/D	9519036/E	

*Disponibile anche con fori sfalsati

*Also available with staggered holes

Coltelli da sagomare di ricambio in HM integrale.

Spare knives to profile HM integral.

Couteaux à profiler de rechange en HM intégral.

Messern zu profilieren zu HM integral.

Cuchillas por perfilar utilizadas como repuestos en HM macizo.

B	ID nr.
BxHxS	n°1 pz
20x20x2	9519 101
20x25x2	9519 102
20x30x2	9519 103
20x35x2	9519 104
25x20x2	9519 105
25x25x2	9519 106
25x30x2	9519 107
25x35x2	9519 108
30x20x2	9519 109
30x25x2	9519 110
30x30x2*	9519 111
30x35x2	9519 112
30x40x2	9519 113
35x25x2	9519 114
35x30x2*	9519 115
35x35x2*	9519 116
35x40x2	9519 117
40x20x2	9519 118
40x25x2	9519 119
40x30x2*	9519 120
40x35x2*	9519 121
40x40x2*	9519 122
50x25x2	9519 123
50x30x2	9519 124
50x35x2	9519 125
50x40x2	9519 126
50x45x2	9519 127
60x30x2	9519 128
60x35x2	9519 129
60x40x2	9519 130
80x30x2	9519 131
80x35x2	9519 132
80x40x2	9519 133

*Disponibile anche con fori sfalsati

*Also available with staggered holes

9519a

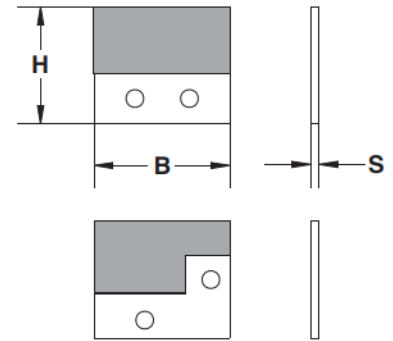

9519b

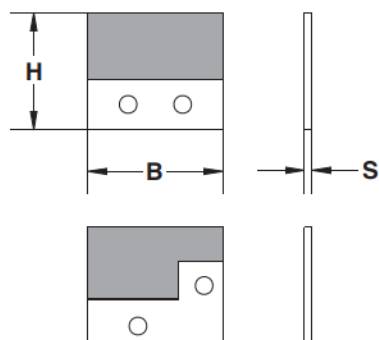

Controcoltelli da sagomare di ricambio in HM integrale.

Spare back-knives to profile HM integral.

Derrière-couteaux à profiler de rechange en HM intégral.

Gegen-Messern zu profilieren zu HM integral.

Contracuchillas por perfilar utilizadas como repuestos en HM macizo.

Dimensioni	ID nr.
BxHxS	n°1 pz
30x28x5	9519 201
30x33x5	9519 202
30x38x5	9519 203
35x28x5	9519 213
35x33x5	9519 214
35x38x5	9519 215
40x28x5	9519 204
40x33x5	9519 205
40x38x5	9519 206
60x28x5	9519 207
60x33x5	9519 208
60x38x5	9519 209
80x28x5	9519 210
80x33x5	9519 211
80x38x5	9519 212

■ = AREA SAGOMABILE / AREA THAT CAN BE SHAPED

9519c

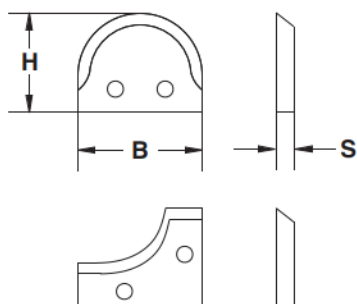

Controcoltelli sagomati di ricambio in HM integrale.

Profiled spare back-knives HM integral.

Derrière-couteaux profilés de rechange en HM intégral.

Gegen-Messern mit profil zu HM integral.

Contracuchillas perfiladas utilizadas como repuestos en HM macizo.

Dimensioni	ID nr.
BxHxS	n°1 pz
30x28x5	9519 301
30x33x5	9519 302
30x38x5	9519 303
35x28x5	9519 313
35x33x5	9519 314
35x38x5	9519 315
40x28x5	9519 304
40x33x5	9519 305
40x38x5	9519 306
60x28x5	9519 307
60x33x5	9519 308
60x38x5	9519 309
80x28x5	9519 310
80x33x5	9519 311
80x38x5	9519 312